

Parchments for CafeOBJ logics

Andrzej Tarlecki

Institute of Informatics, University of Warsaw

Joint work with:

Till Mossakowski, Wiesiek Pawłowski, Don Sannella

CafeOBJ cube of logics

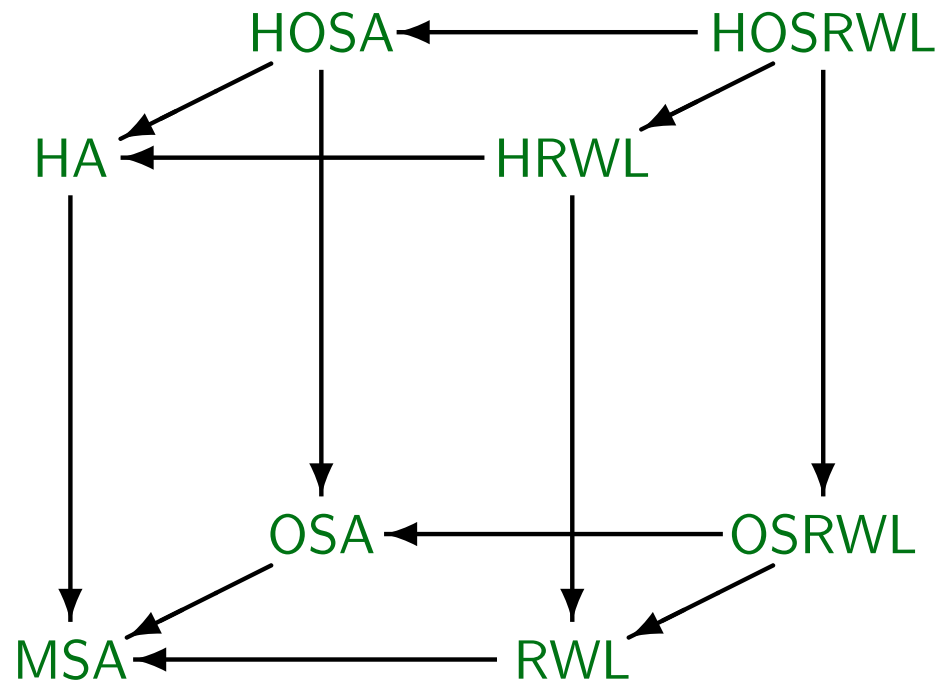

H = hidden (behavioural)

A = algebra

O = order

M = many

S = sorted

RWL = rewriting logic

Main tool

Goguen & Burstall: 1980 → 1992

Institutions

- a standard formalization of the concept of the underlying logical system for specification formalisms and most work on foundations of software specification and development from algebraic perspective;
- a formalization of the concept of a logical system for foundational studies:
 - truly abstract model theory
 - proof-theoretic considerations
 - heterogeneous logical environments

using the basics of category theory

Institution: abstraction

Sen

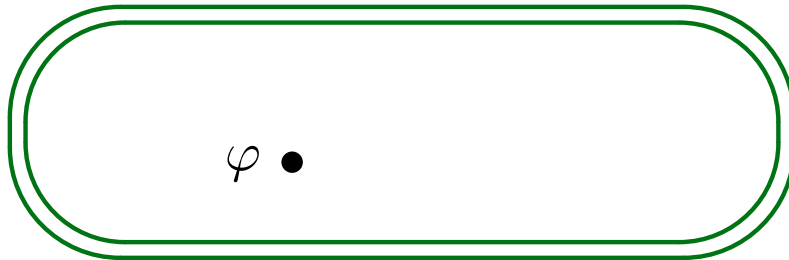

plus *satisfaction relation*:

$$M \models \varphi$$

and so the usual Galois connection between classes of models and sets of sentences, with the standard notions induced ($Mod[\Phi]$, $Th[\mathcal{M}]$, $Th[\Phi]$, $\Phi \models \varphi$, etc).

- Also, possibly adding (sound) consequence: $\Phi \vdash \varphi$ (implying $\Phi \models \varphi$) to deal with proof-theoretic aspects.

Meseguer \sim 1987 \rightarrow 1989

Mod

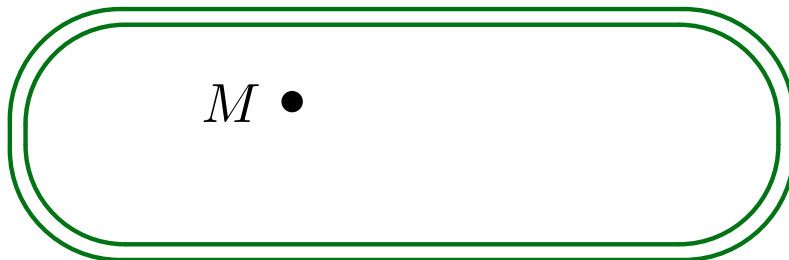

Institution: first insight

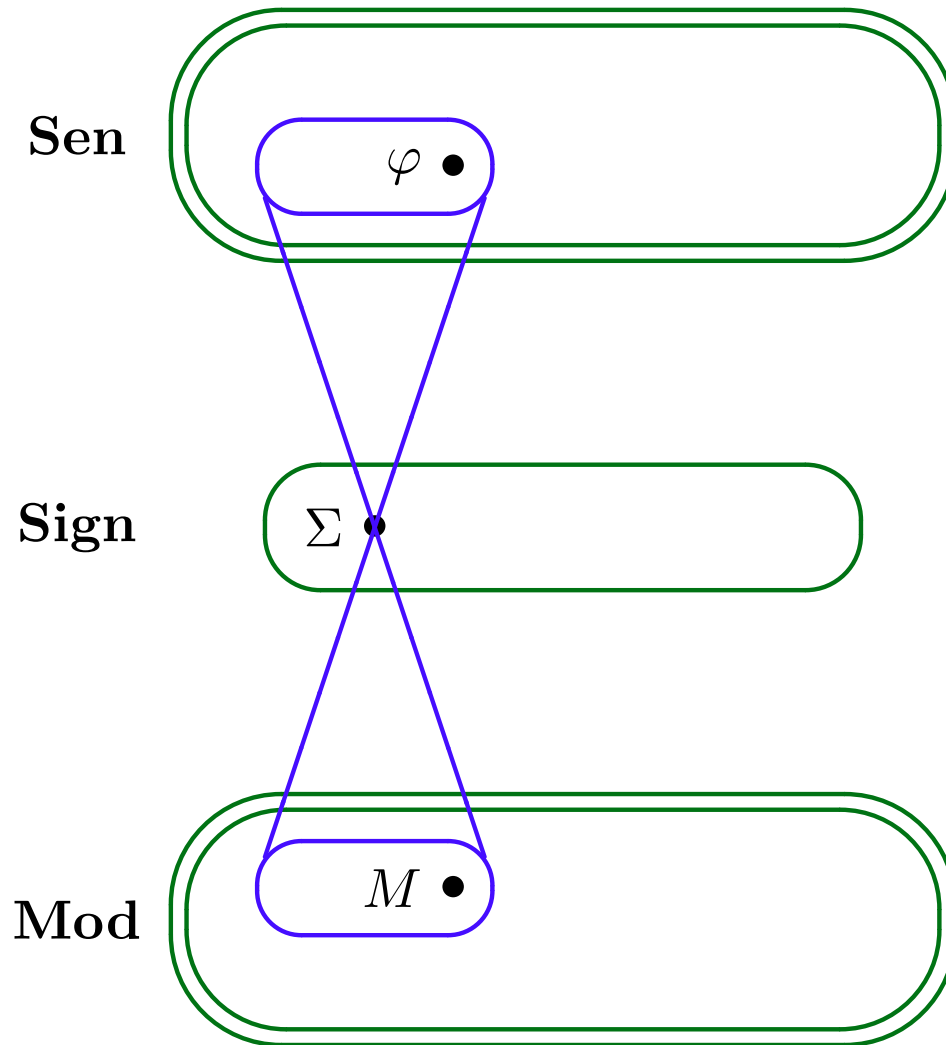

plus *satisfaction relation*:

$$M \models_{\Sigma} \varphi$$

and so, for each signature, the usual Galois connection between classes of models and sets of sentences, with the standard notions induced ($Mod_{\Sigma}[\Phi]$, $Th_{\Sigma}[\mathcal{M}]$, $Th_{\Sigma}[\Phi]$, $\Phi \models_{\Sigma} \varphi$, etc).

- Also, possibly adding (sound) consequence: $\Phi \vdash_{\Sigma} \varphi$ (implying $\Phi \models_{\Sigma} \varphi$) to deal with proof-theoretic aspects.

Institution: key insight

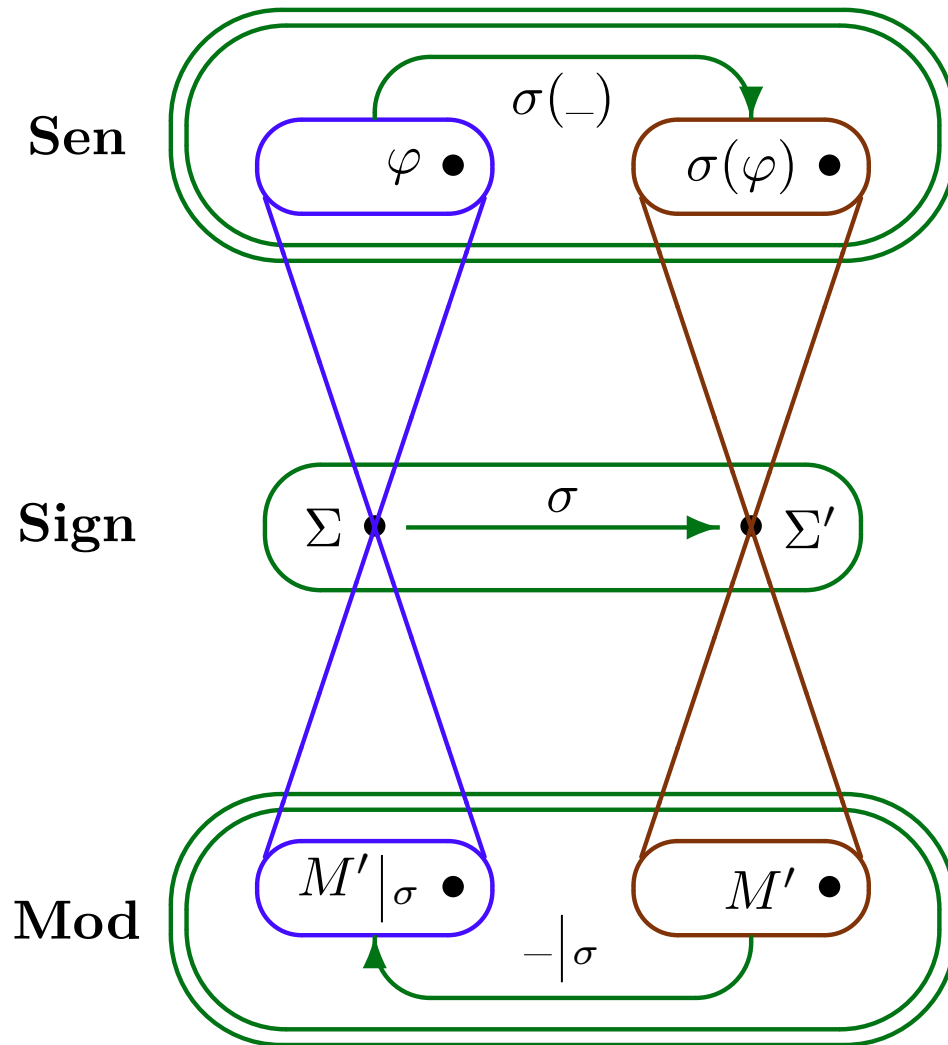

imposing the *satisfaction condition*:

$$M' \models_{\Sigma'} \sigma(\varphi) \text{ iff } M' |_{\sigma} \models_{\Sigma} \varphi$$

*Truth is invariant
under change of notation
and independent of
any additional symbols around*

Institution

An *institution* $\mathbf{I} = \langle \mathbf{Sign}, \mathbf{Sen}, \mathbf{Mod}, \models \rangle$ consists of:

- a category \mathbf{Sign} of *signatures*
- a functor $\mathbf{Sen}: \mathbf{Sign} \rightarrow \mathbf{Set}$
 - $\mathbf{Sen}(\Sigma)$ is the set of Σ -*sentences*, for $\Sigma \in |\mathbf{Sign}|$
- a functor $\mathbf{Mod}: \mathbf{Sign}^{op} \rightarrow \mathbf{Class}$
 - $\mathbf{Mod}(\Sigma)$ is the class of Σ -*models*, for $\Sigma \in |\mathbf{Sign}|$
- for each $\Sigma \in |\mathbf{Sign}|$, Σ -*satisfaction relation* $\models_{\Sigma} \subseteq \mathbf{Mod}(\Sigma) \times \mathbf{Sen}(\Sigma)$

subject to the *satisfaction condition*:

$$M' \upharpoonright_{\sigma} \models_{\Sigma} \varphi \iff M' \models_{\Sigma'} \sigma(\varphi)$$

where $\sigma: \Sigma \rightarrow \Sigma'$ in \mathbf{Sign} , $M' \in \mathbf{Mod}(\Sigma')$, $\varphi \in \mathbf{Sen}(\Sigma)$,
 $M' \upharpoonright_{\sigma}$ stands for $\mathbf{Mod}(\sigma)(M')$, and $\sigma(\varphi)$ for $\mathbf{Sen}(\sigma)(\varphi)$.

Examples abound

- typical:
 - classics: equational logic; first-order logic (with predicates and equality); higher-order logic; also with partial operations
 - logics of CafeOBJ: many-sorted equational logic; order-sorted equational logic; many-sorted logic of rewritings; order-sorted logic of rewritings; behavioural (hidden) many-sorted equational logic; behavioural (hidden) order-sorted equational logic; behavioural (hidden) many-sorted logic of rewritings; behavioural (hidden) order-sorted logic of rewritings.
- not so typical:
 - modal logics; logics of constraints; three-valued logics
 - programming language semantics
- perhaps unexpected:
 - no sentences; no models; no signatures; trivial satisfaction relations
 - sets of sentences as sentences; sets of sentences as signatures; classes of models as sentences; sets of sentences as models

Our starting point

- *Trivial algebraic institution:*

$$A = \langle \mathbf{AlgSig}, \mathbf{Sen}^{\emptyset}, \mathbf{Alg}, \models^{\emptyset} \rangle$$

many-sorted signatures Σ , no sentences, and Σ -algebras A

- *Ground equational institution:*

$$\mathbf{GMSA} = \langle \mathbf{AlgSig}, \mathbf{GEQ}, \mathbf{Alg}, \models \rangle$$

many-sorted signatures Σ , ground Σ -equations $t = t'$, Σ -algebras A , and the usual satisfaction $A \models t = t'$

- *Ground order-sorted equational institution:*

$$\text{GOSA} = \langle \text{OSSig}, \text{GOSEQ}, \text{OSAlg}, \models \rangle$$

order-sorted signatures $\langle \Sigma, \leq \rangle$, ground $\langle \Sigma, \leq \rangle$ -equations $t = t'$ (terms with subsort inclusions and retracts), $\langle \Sigma, \leq \rangle$ -algebras A , and the usual satisfaction $A \models t = t'$ with partial evaluation of terms

- *Ground rewriting institution:*

$$\text{GPRWL} = \langle \text{AlgSig}, \text{GRW}, \text{RAlg}, \models \rangle$$

many-sorted signatures Σ , ground Σ -rewritings $t \Rightarrow t'$, rewriting (or: preordered) Σ -algebras $\langle A, \preceq \rangle$, and satisfaction $\langle A, \preceq \rangle \models t \Rightarrow t'$ that interprets \Rightarrow as \preceq

- *Ground behavioural equational institution:*

$$\text{GHA} = \langle \text{BehSig}, \text{GBEQ}, \text{Alg}, \models \rangle$$

behavioural signatures $\langle \Sigma, \text{OBS} \rangle$, ground behavioural Σ -equations $t \sim t'$, Σ -algebras A , and satisfaction $A \models t \sim t'$ that interprets \sim as OBS -indistinguishability

CafeOBJ cube of ground logics

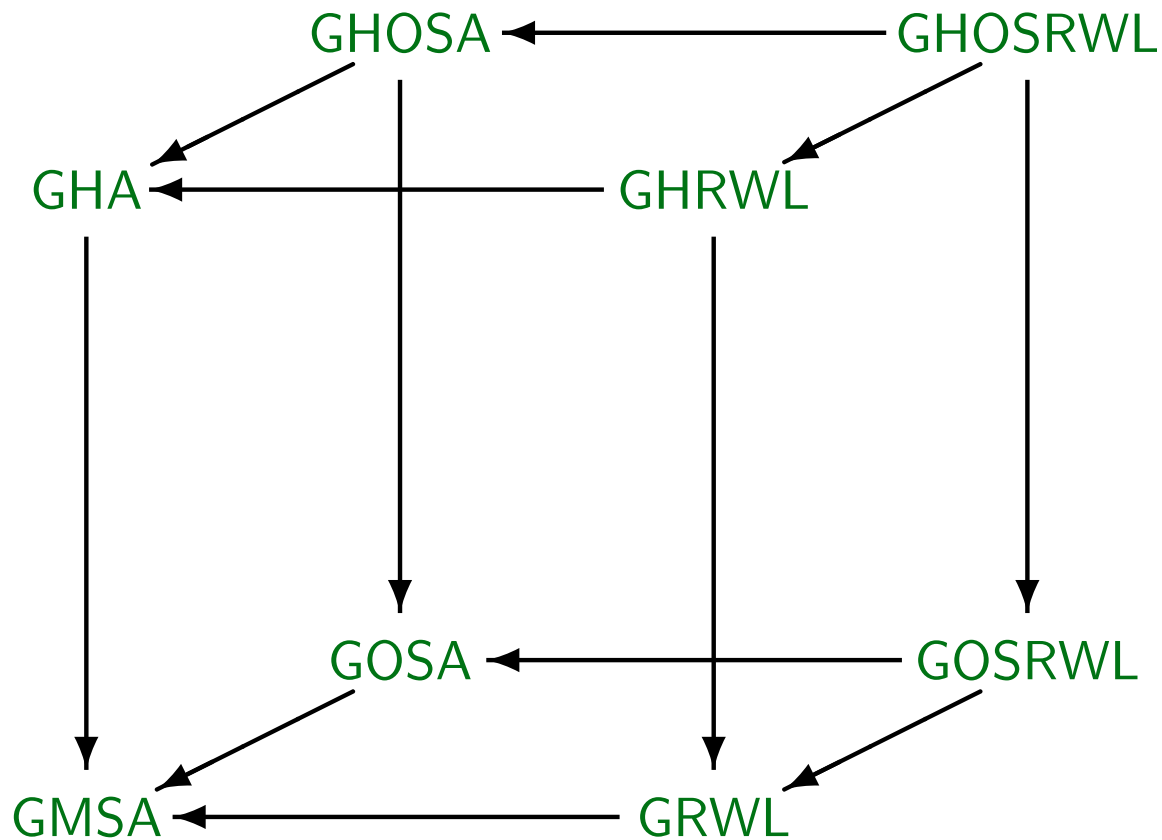

G = ground

H = hidden (behavioural)

A = algebra

O = order

M = many

S = sorted

RWL = rewriting logic

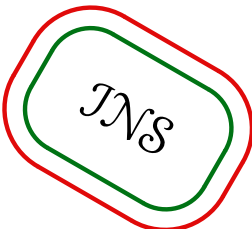

Institution morphism: $\mu: \mathbf{I} \longrightarrow \mathbf{I}'$

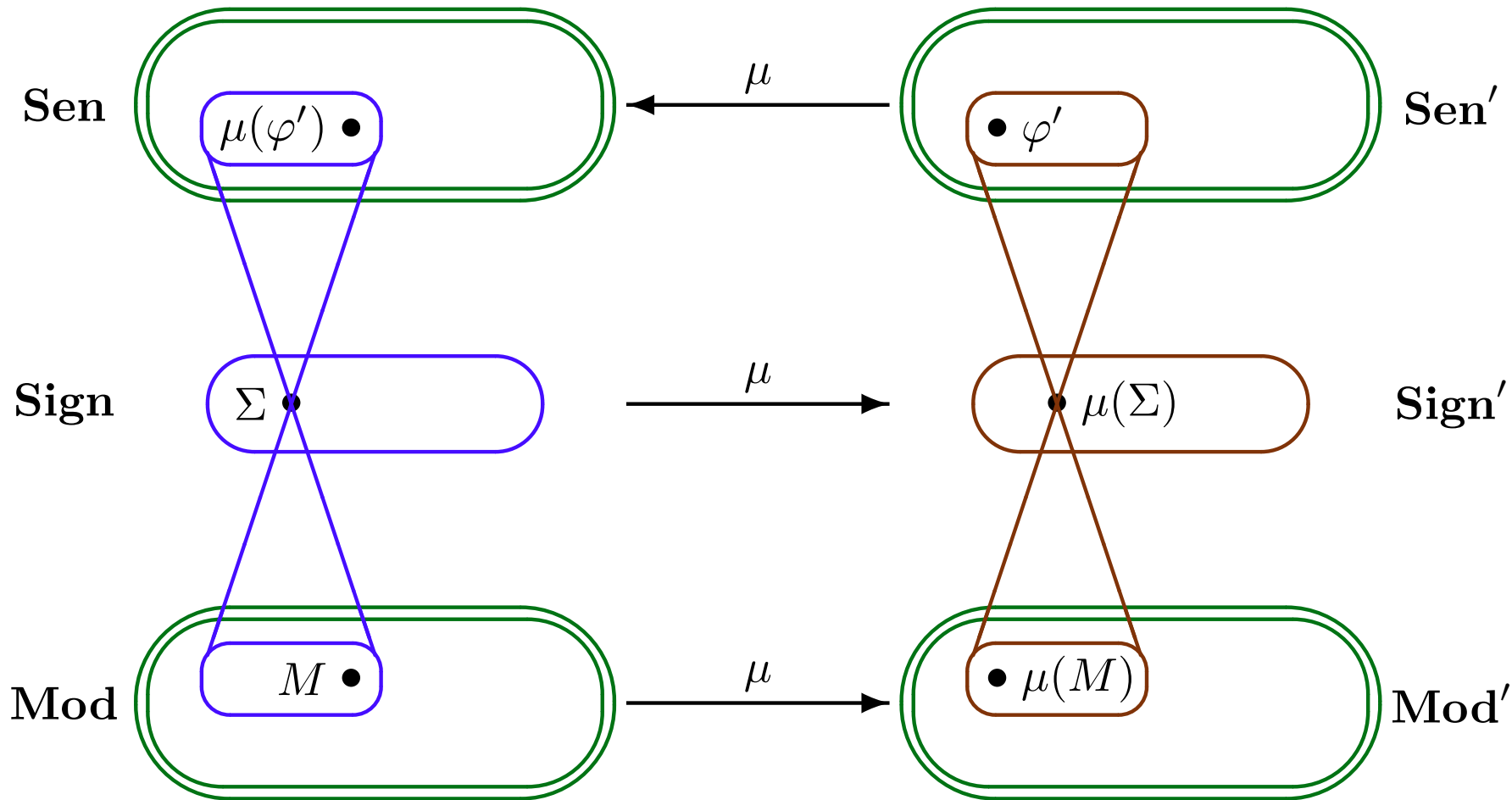

with the *satisfaction condition* lurking again:

$$M \models \mu(\varphi) \text{ iff } \mu(M) \models' \varphi$$

Institution morphism

An *institution morphism* $\mu: \mathbf{I} \longrightarrow \mathbf{I}'$ consists of:

- a functor $\mu: \mathbf{Sign} \rightarrow \mathbf{Sign}'$,
- a natural transformation $\mu: \mathbf{Mod} \rightarrow (\mu)^{op};\mathbf{Mod}'$, and
- a natural transformation $\mu: \mu;\mathbf{Sen}' \rightarrow \mathbf{Sen}$

subject to the following *satisfaction condition*:

$$M \models_{\Sigma} \mu(\varphi) \text{ iff } \mu(M) \models'_{\mu(\Sigma)} \varphi'$$

where $\Sigma \in |\mathbf{Sign}|$, $M \in \mathbf{Mod}(\Sigma)$ and $\varphi' \in \mathbf{Sen}'(\mu(\Sigma))$.

With straightforward component-wise composition this yields

the category of institutions and their morphisms

JNS

Sample institution morphisms

- trivial morphisms: $GMSA \longrightarrow A$, $GOSA \longrightarrow A$, $GPRWL \longrightarrow A$, $GHA \longrightarrow A$
- $GOSA \longrightarrow A$ easily extends to $GOSA \longrightarrow GMSA$
- $GHA \longrightarrow A$ does not extend to $GHA \longrightarrow GMSA$
- $GHA \longrightarrow GMSA$, given by mapping $\langle \langle S, \Omega \rangle, OBS \rangle \mapsto \langle OBS, \Omega_{OBS} \rangle$

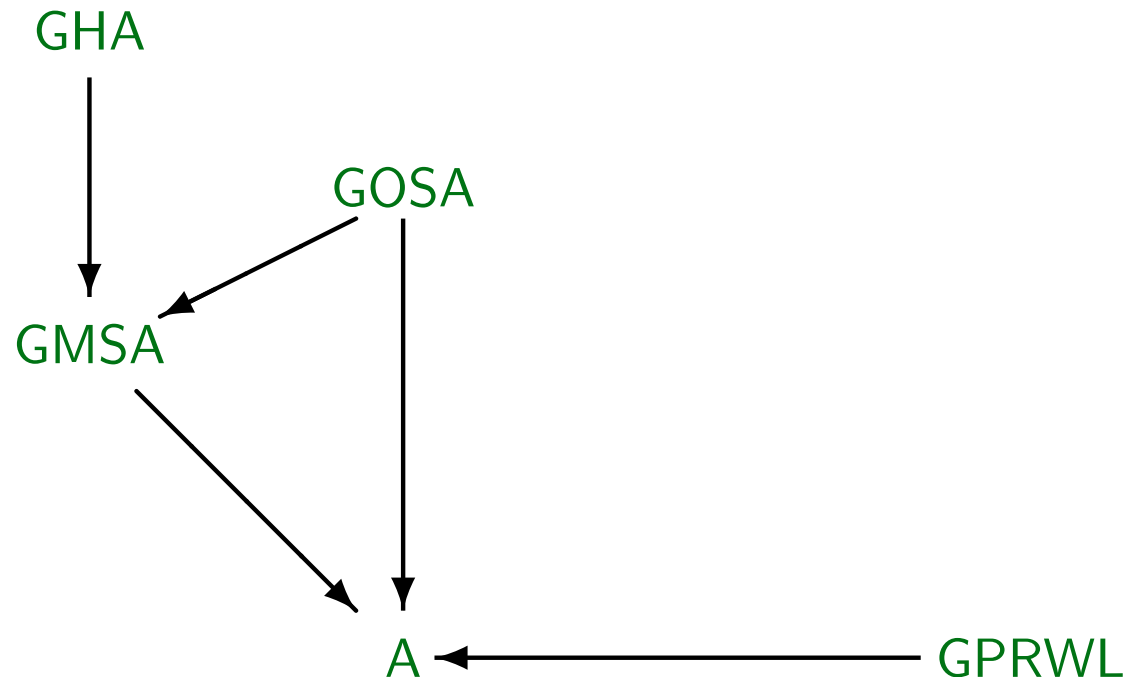

Institution limits

Fact: *The category \mathcal{INS} of institutions and institution morphisms is complete.*

Proof: To build the limit of a diagram of institutions:

- **Category of signatures:** the limit of the categories of signatures of the institutions in the institution diagram; the resulting signatures "combine" signatures from the institutions in the diagram
- For each of the resulting signatures:
 - **the set of sentences:** the colimit of sets of sentences over individual signatures it combines, linked by sentence translations in the institution diagram
 - **the class of models:** the limit of classes of models over individual signatures it combines, linked by model translations in the institution diagram
 - **satisfaction relation:** given uniquely so that the satisfaction condition holds for institution projection morphisms
- For each signature morphism, **the translations of sentences and models:** given by the colimit/limit properties.

Putting institutions together

\mathcal{INS} is complete.

- Limits in \mathcal{INS} : a rudimentary way of combining institutions linked by institution morphisms to capture how one institution is built over another.
- This is in contrast with the *Grothendieck institution* built over the same diagram, which just puts the institutions involved next to each other, with additional signature morphisms induced by institution morphisms.

Example

- GRWL is the pullback of GMSA and GPRWL over A

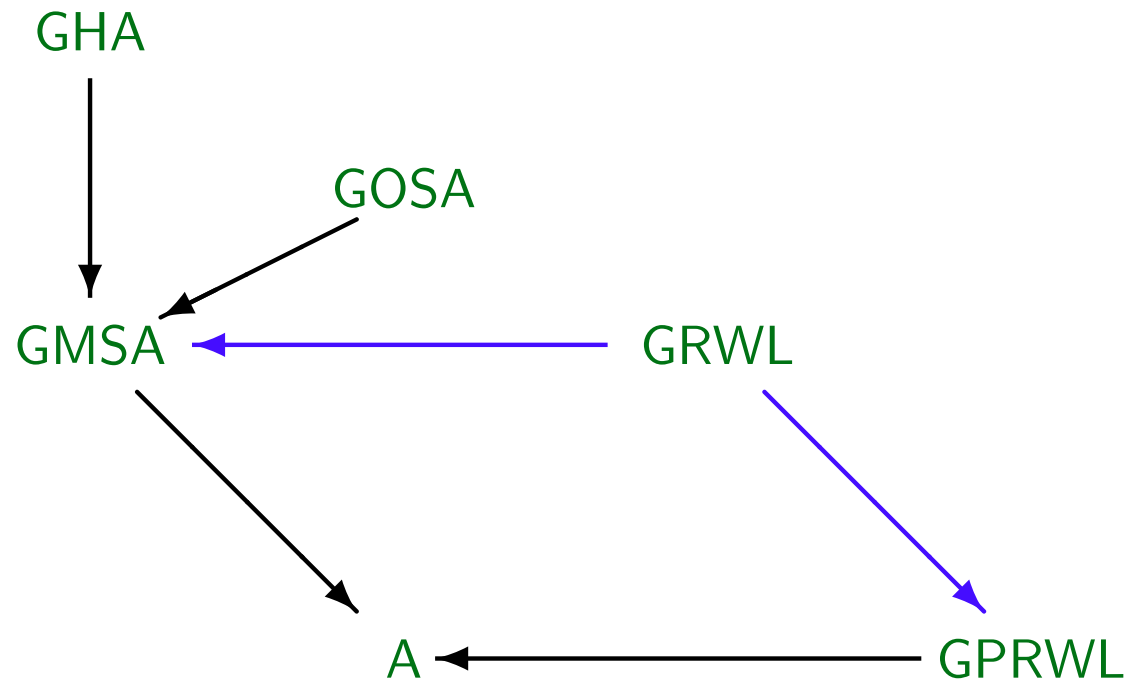

- Other pullbacks do not give the expected results!*
E.g.: the pullback of GOSA and GRWL does not have rewritings between terms with subsort inclusions or retracts

No feature interleaving

Parchments

Formal structures to present institutions

Goguen & Burstall: 1985

- We will work with a “model-theoretic” version (rather than relying on super-large “universal” signatures and semantic structures).

M-T Parchment

A *model-theoretic parchment* $\mathbf{P} = \langle \mathbf{Sign}, \mathbf{Mod}, \mathbf{L}, \mathcal{G} \rangle$ consists of

- a category \mathbf{Sign} of signatures,
- a functor $\mathbf{Mod}: \mathbf{Sign}^{op} \rightarrow \mathbf{Class}$ (as for institutions),
- a functor $\mathbf{L}: \mathbf{Sign} \rightarrow \mathbf{AlgSig}_*$ giving the abstract syntax of sentences,
- for $\Sigma \in |\mathbf{Sign}|$ and $M \in \mathbf{Mod}(\Sigma)$, an $\mathbf{L}(\Sigma)$ -structure $\mathcal{G}_\Sigma(M) \in |\mathbf{Str}(\mathbf{L}(\Sigma))|$ which determines semantics for Σ -syntax (in particular: semantic evaluation of Σ -sentences in M)
- for $\sigma: \Sigma \rightarrow \Sigma'$ and $M' \in \mathbf{Mod}(\Sigma')$, an $\mathbf{L}(\Sigma)$ -homomorphism $\mathcal{G}_\sigma(M'): \mathcal{G}_\Sigma(M'|_\sigma) \rightarrow \mathcal{G}_{\Sigma'}(M')|_{\mathbf{L}(\sigma)}$, compositional in σ , to capture uniformity of the semantics

where: \mathbf{AlgSig}_* is the category of many-sorted signatures with a distinguished “logical” sort $*$ and a predicate \mathbf{D} on $*$.

M-T Parchment

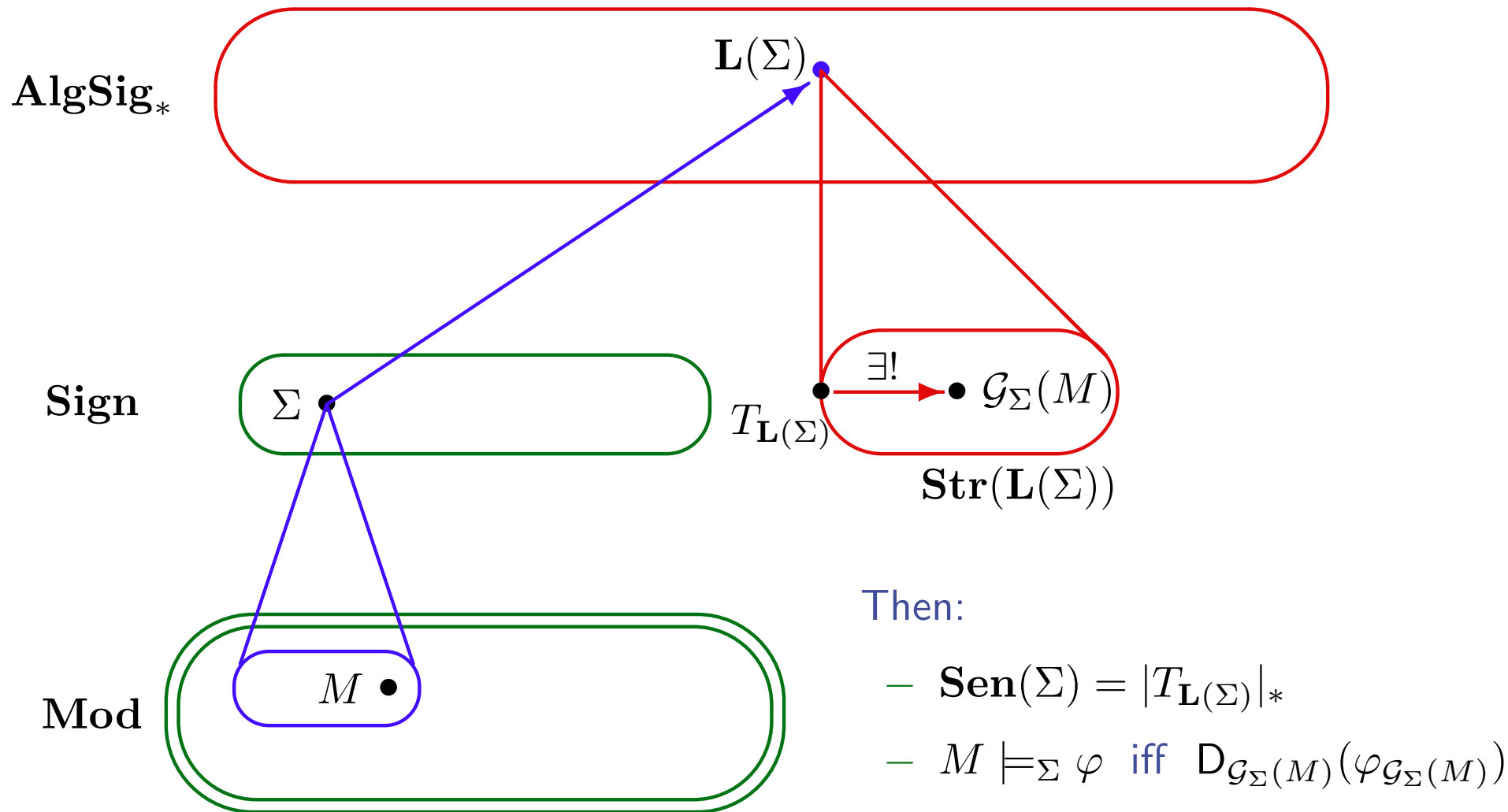

M-T Parchment

AlgSig_{*}

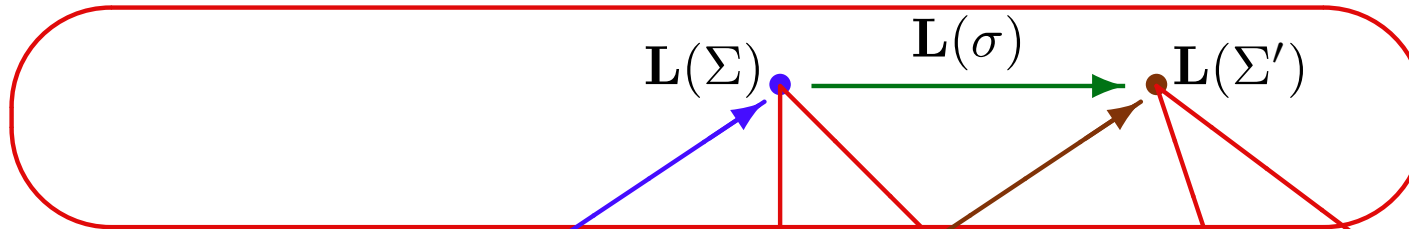

Sign

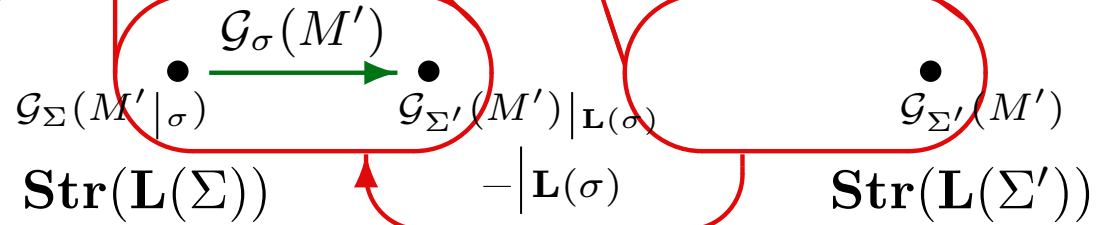
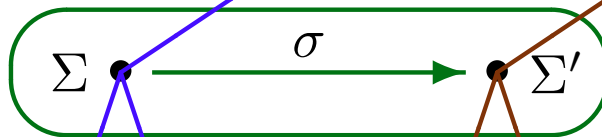

Str(L(Σ))

-|L(σ)

Str(L(Σ'))

Mod

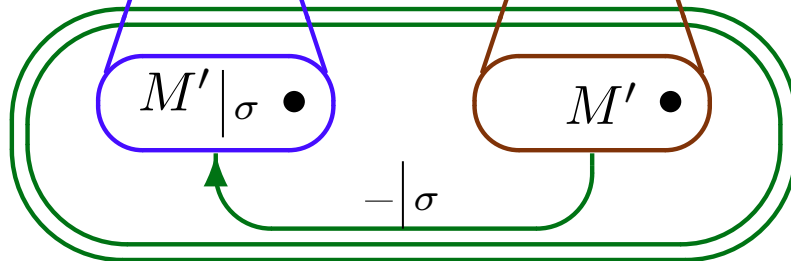

To ensure the satisfaction condition, require parchments to be *institutional*:

$$\mathcal{G}_{\sigma}(M') : \mathcal{G}_{\Sigma}(M'|_{\sigma}) \rightarrow \mathcal{G}_{\Sigma'}(M')|_{L(\sigma)}$$

preserves and reflects $D : *$.

From institutional parchments to institutions

Institutional parchment \mathbf{P} presents institution $\mathcal{J}(\mathbf{P})$

$\mathbf{P} = \langle \mathbf{Sign}, \mathbf{Mod}, \mathbf{L}, \mathcal{G} \rangle$ *presents* $\mathcal{J}(\mathbf{P}) = \langle \mathbf{Sign}, \mathbf{Sen}, \mathbf{Mod}, \models \rangle$

where:

- \mathbf{Sign} is inherited from \mathbf{P}
- \mathbf{Sen} is $|T_{\mathbf{L}(-)}|_*$, so that for $\Sigma \in |\mathbf{Sign}|$, $\mathbf{Sen}(\Sigma) = |T_{\mathbf{L}(\Sigma)}|_*$
- \mathbf{Mod} is inherited from \mathbf{P}
- $M \models_{\Sigma} \varphi$ iff $D_{\mathcal{G}_{\Sigma}(M)}(\varphi_{\mathcal{G}_{\Sigma}(M)})$, for $\Sigma \in |\mathbf{Sign}|$, $M \in \mathbf{Mod}(\Sigma)$, $\varphi \in |T_{\mathbf{L}(\Sigma)}|_*$

Satisfaction condition holds if \mathbf{P} is institutional

Our starting point

- $\mathbf{P}_A = \langle \mathbf{AlgSig}, \mathbf{L}^A, \mathbf{Alg}, \mathcal{G}^A \rangle$ presents $A = \mathcal{J}(\mathbf{P}_A)$:

$\mathbf{L}^A(\Sigma)$ extends Σ with $*$ and $D : *$

- $\mathbf{P}_{\text{GMSA}} = \langle \mathbf{AlgSig}, \mathbf{L}^{\text{GMSA}}, \mathbf{Alg}, \mathcal{G}^{\text{GMSA}} \rangle$ presents $\text{GMSA} = \mathcal{J}(\mathbf{P}_{\text{GMSA}})$:

$\mathbf{L}^{\text{GMSA}}(\Sigma)$ extends $\mathbf{L}^A(\Sigma)$ with $eq : s \times s \rightarrow *$ for each sort s , interpreted as the diagonal in $\mathcal{G}_{\Sigma}^{\text{GMSA}}(A)$

- $\mathbf{P}_{\text{GOSA}} = \langle \mathbf{OSSig}, \mathbf{L}^{\text{GOSA}}, \mathbf{OSAlg}, \mathcal{G}^{\text{GOSA}} \rangle$ presents $\text{GOSA} = \mathcal{J}(\mathbf{P}_{\text{GOSA}})$:

$\mathbf{L}^{\text{OSA}}(\langle \Sigma, \leq \rangle)$ extends $\mathbf{L}^A(\Sigma)$ with subsort inclusions and retracts, as well as $eq : s \times s \rightarrow *$ for each sort s , and $\mathcal{G}_{\langle \Sigma, \leq \rangle}^{\text{GOSA}}(A)$ adds to A new values \perp and interprets the new operations as expected

- $\mathbf{P}_{\text{GPRWL}} = \langle \mathbf{AlgSig}, \mathbf{L}^{\text{GPRWL}}, \mathbf{RAlg}, \mathcal{G}^{\text{GPRWL}} \rangle$ presents $\text{GPRWL} = \mathcal{J}(\mathbf{P}_{\text{GPRWL}})$:

$\mathbf{L}^{\text{GPRWL}}(\Sigma)$ extends $\mathbf{L}^A(\Sigma)$ with $rwr : s \times s \rightarrow *$ for each sort s , interpreted as \preceq in $\mathcal{G}_{\Sigma}^{\text{GPRWL}}(\langle A, \preceq \rangle)$

- $\mathbf{P}_{\text{GHA}} = \langle \mathbf{BehSig}, \mathbf{L}^{\text{GHA}}, \mathbf{Alg}, \mathcal{G}^{\text{GHA}} \rangle$ presents $\text{GHA} = \mathcal{J}(\mathbf{P}_{\text{GHA}})$:

$\mathbf{L}^{\text{GHA}}(\langle \Sigma, \text{OBS} \rangle)$ extends $\mathbf{L}^A(\Sigma)$ with $beq : s \times s \rightarrow *$ for each sort s , interpreted as OBS -indistinguishability in $\mathcal{G}_{\langle \Sigma, \text{OBS} \rangle}^{\text{GHA}}(A)$

Example

- $\mathbf{P}_{\text{GOSA}} = \langle \mathbf{OSSig}, \mathbf{L}^{\text{GOSA}}, \mathbf{OSAlg}, \mathcal{G}^{\text{GOSA}} \rangle$ presents $\text{GOSA} = \mathcal{J}(\mathbf{P}_{\text{GOSA}})$:

Syntax: for any order-sorted signature $\langle \Sigma, \leq \rangle$, $\mathbf{L}^{\text{OSA}}(\langle \Sigma, \leq \rangle)$ consists of

- sort $*$ with predicate $\mathbf{D}: *$
- all sort and operation names from Σ
- for any sort names $s \leq s'$ in Σ , operation names for subsort inclusion and retract $i: s \rightarrow s'$ and $r: s' \rightarrow s$
- for any sort name s in Σ , operation name for equality $eq: s \times s \rightarrow *$

Semantics: for any order-sorted signature $\langle \Sigma, \leq \rangle$ and order-sorted algebra $A \in \mathbf{OSAlg}(\langle \Sigma, \leq \rangle)$, the evaluation structure $\mathcal{G}_{\langle \Sigma, \leq \rangle}^{\text{GOSA}}(A)$ is given as follows

- the carrier of sort $*$ is $\text{Bool} = \{tt, ff\}$, $\mathbf{D}: *$ holds for tt , as usual
- the carriers for sort names in Σ are the corresponding carriers of A with a new value \perp added
- the operations from Σ are interpreted as in A , extended to preserve \perp
- subsort inclusions are interpreted as inclusions and retracts as partial projections, yielding \perp for extra values in the supersort carriers
- equalities eq yield tt for equal arguments in $|A|$, and ff otherwise

Parchment morphism

A (model-theoretic) *parchment morphism* $\gamma: \mathbf{P} \longrightarrow \mathbf{P}'$ consists of:

- a functor $\gamma: \mathbf{Sign} \rightarrow \mathbf{Sign}'$,
- a natural transformation $\gamma: \mathbf{Mod} \rightarrow (\gamma)^{op}; \mathbf{Mod}'$,
- a natural transformation $\gamma: \gamma; \mathbf{L}' \rightarrow \mathbf{L}$, and
- for $\Sigma \in |\mathbf{Sign}|$ and $M \in \mathbf{Mod}(\Sigma)$, an $\mathbf{L}'(\gamma(\Sigma))$ -homomorphism

$$g_{\Sigma, M}: \mathcal{G}'_{\gamma(\Sigma)}(\gamma_{\Sigma}(M)) \rightarrow \mathcal{G}_{\Sigma}(M) \Big|_{\gamma_{\Sigma}}$$

subject to the routine (though not easy) naturality condition:

for $\sigma: \Sigma_1 \rightarrow \Sigma_2$ and $M_2 \in \mathbf{Mod}(\Sigma_2)$,

$$g_{\Sigma_1, M_2} \Big|_{\sigma}; \mathcal{G}_{\sigma}(M_2) \Big|_{\gamma_{\Sigma_1}} = \mathcal{G}'_{\gamma(\sigma)}(\gamma_{\Sigma_2}(M_2)); g_{\Sigma_2, M_2} \Big|_{\mathbf{L}'(\gamma(\sigma))}$$

(which makes g a 2-natural transformation...).

Parchment morphisms: $\gamma: P \longrightarrow P'$

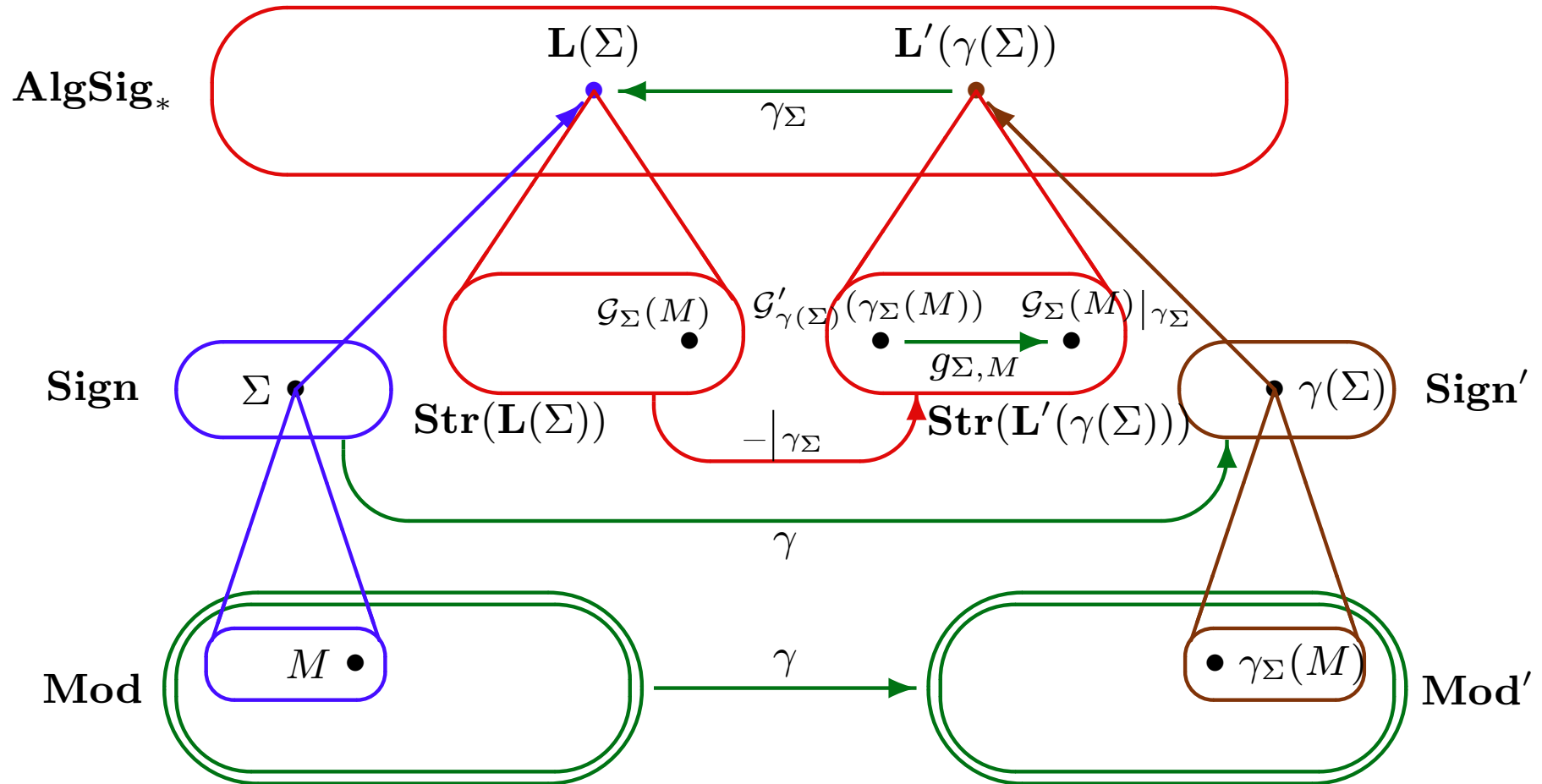

γ is *institutional* if $g_{\Sigma, M}: \mathcal{G}'_{\gamma(\Sigma)}(\gamma_\Sigma(M)) \rightarrow \mathcal{G}_\Sigma(M)|_{\gamma_\Sigma}$ preserves and reflects $D: *$.

From institutional parchments to institutions

Fact: *There is a functor*

$$\mathcal{J}: \mathcal{IPAR} \rightarrow \mathcal{INS}$$

that maps institutional parchments to institutions and institutional parchment morphisms to institution morphisms.

Indeed, institutional parchments smoothly present institutions!

BUT: the construction only “nearly works” for arbitrary (non-institutional) parchments and parchment morphisms — the satisfaction condition may fail.

Sample parchment morphisms

- trivial *institutional* morphisms: $\mathbf{P}_{\text{GMSA}} \rightarrow \mathbf{P}_A$, $\mathbf{P}_{\text{GOSA}} \rightarrow \mathbf{P}_A$, $\mathbf{P}_{\text{GPRWL}} \rightarrow \mathbf{P}_A$, $\mathbf{P}_{\text{GHA}} \rightarrow \mathbf{P}_A$
- $\mathbf{P}_{\text{GOSA}} \rightarrow \mathbf{P}_A$ easily extends to *institutional* $\mathbf{P}_{\text{GOSA}} \rightarrow \mathbf{P}_{\text{GMSA}}$
- $\mathbf{P}_{\text{GHA}} \rightarrow \mathbf{P}_A$ easily extends to *non-institutional* $\mathbf{P}_{\text{GHA}} \rightarrow \mathbf{P}_{\text{GMSA}}$
- *institutional* $\mathbf{P}_{\text{GHA}} \rightarrow \mathbf{P}_{\text{GMSA}}$, given by mapping $\langle \langle S, \Omega \rangle, \text{OBS} \rangle \mapsto \langle \text{OBS}, \Omega_{\text{OBS}} \rangle$

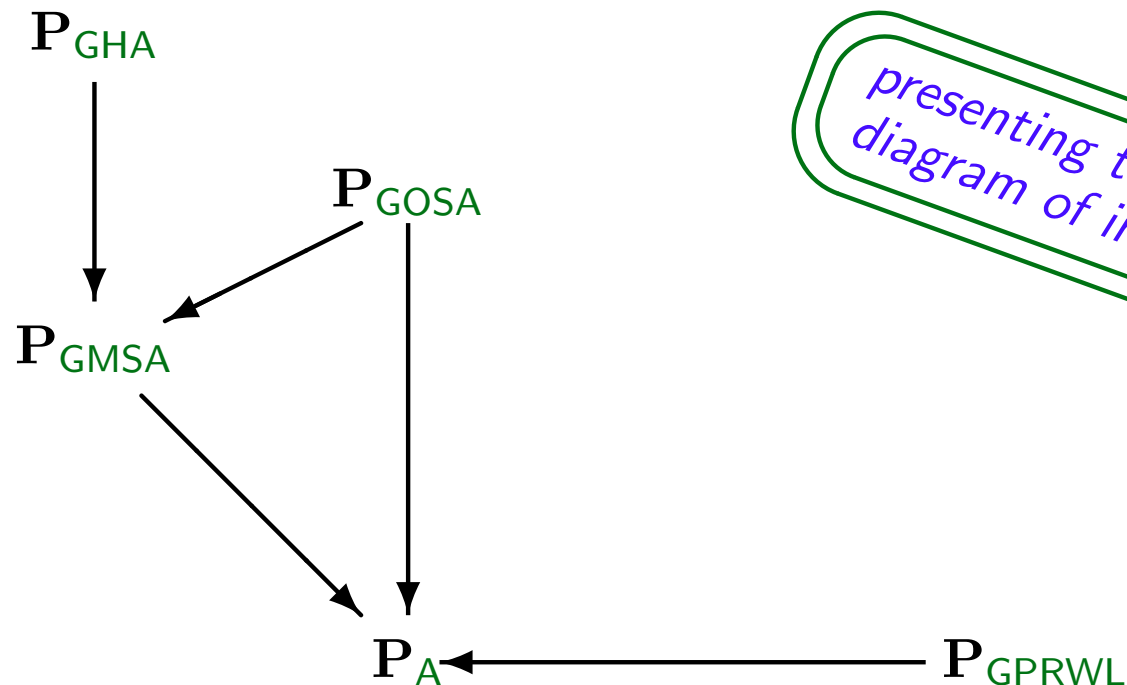

presenting the corresponding
diagram of institutions

Parchment limits

Fact: *The category \mathcal{PAR} of parchments and their morphisms is complete.*

Fact: *The category \mathcal{IPAR} of institutional parchments and their institutional morphisms is **not** complete.*

NO MIRACLES!

Fact: *Given a diagram of institutional parchments and their institutional morphisms in \mathcal{IPAR} , its limiting cone in \mathcal{PAR} consists of institutional parchment morphisms, although the limit parchment may be non-institutional.*

Fact: *Given a diagram of institutional parchments and their institutional morphisms in \mathcal{IPAR} , even if its limit in \mathcal{PAR} is institutional, it does not have to be its limit in \mathcal{IPAR} .*

Putting parchments together

- The pullback of \mathbf{P}_{GMSA} and $\mathbf{P}_{\text{GPRWL}}$ over \mathbf{P}_A in \mathcal{PAR} is their pullback in \mathcal{JPAR} and presents GRWL .

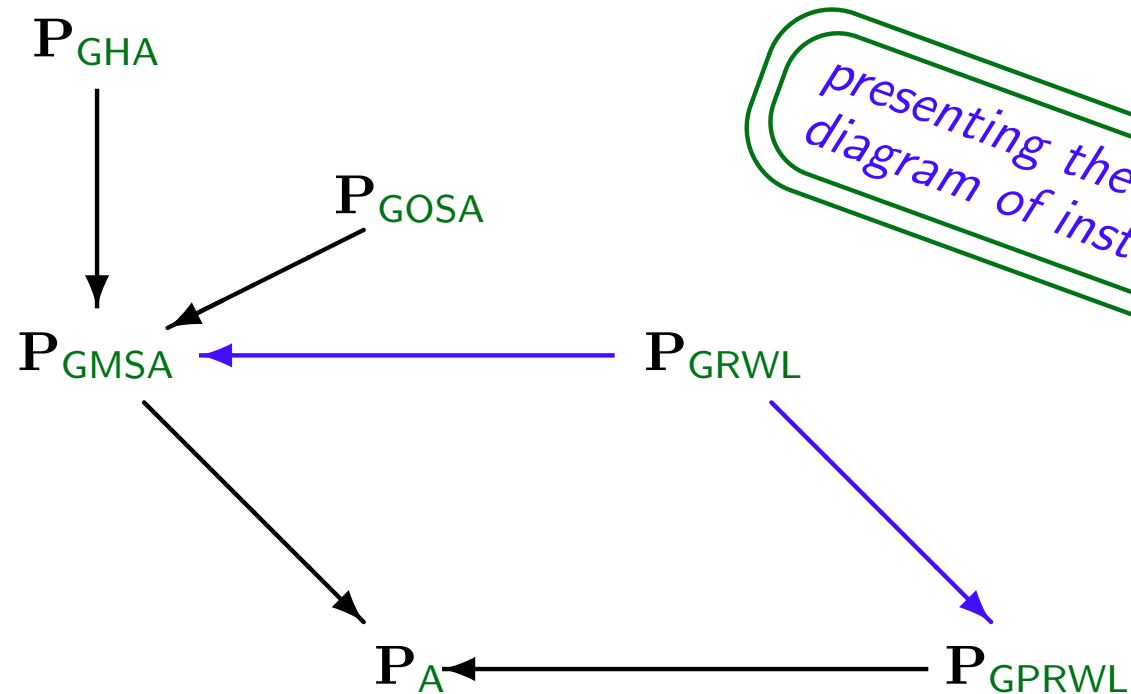

- Other pullbacks do not give the expected results!*

Problems caused by feature interleaving

Good parchments combinations

no new logical values!

Given a diagram of institutional parchments and their institutional morphisms, a cone of institutional morphisms on this diagram is a *complete joint extension* if each of the logical values in any of the evaluation structures of its vertex parchment corresponds to a logical value in an evaluation structure of a parchment in the diagram.

Fact: *Given a diagram of institutional parchments and their institutional morphisms in \mathcal{JPAR} , if its limiting cone in \mathcal{PAR} is a complete joint extension, then it is the limit of this diagram in \mathcal{JPAR} .*

Adjusting limit parchments

Typically: new feature interleavings *freely generate new semantic values*, including those in the sort $*$, thus indicating where essential semantic design decisions are necessary for the logic combination

Technique: choose *complete coherent family congruences* on the evaluation structures in the limit parchment to glue the new “logical” values with the standard (old) ones; then the quotient of the limit parchment becomes a complete joint extension of the parchments in the diagram

Parchment extension

Typically: new features may be freely added to the syntax part of a parchment, resulting in its free extension with *freely generated new semantic values*, including those in the sort $*$, thus indicating where essential semantic design decisions are necessary for the logic extension

Technique: choose *complete coherent family congruences* on the evaluation structures in the freely extended parchment to glue the new “logical” values with the standard (old) ones; then the quotient of the freely extended parchment becomes a complete (joint) extension of the original parchment

Examples

GOSRWL: The pullback of \mathbf{P}_{GOSA} and \mathbf{P}_{GRWL} over \mathbf{P}_{GMSA} in \mathcal{PAR} involves evaluation structures where rewritings between terms that evaluate to \perp generate new logical values. Identifying these new logical values with ff yields a complete coherent family congruences. Put \mathbf{P}_{GOSRWL} to be the quotient of the pullback parchment by this family. We thus get a presentation of **GOSRWL**.

GHRWL: The pullback of \mathbf{P}_{GHA} and \mathbf{P}_{GRWL} over \mathbf{P}_{GMSA} in \mathcal{PAR} is in fact a complete joint extension — so it is a combination of the two logics.

BUT: the pullback misses rewritings between terms of non-observable sorts.

First, these can be added freely. Then, we can choose a complete coherent family of congruences by gluing the logical values built by behavioural rewritings with tt if the two argument values are in the largest precongruence determined by the observable preorder, and with ff otherwise. Put \mathbf{P}_{GOSRWL} to be the quotient of the pullback parchment by this family. We thus get a presentation of **GHRWL**.

We have now:

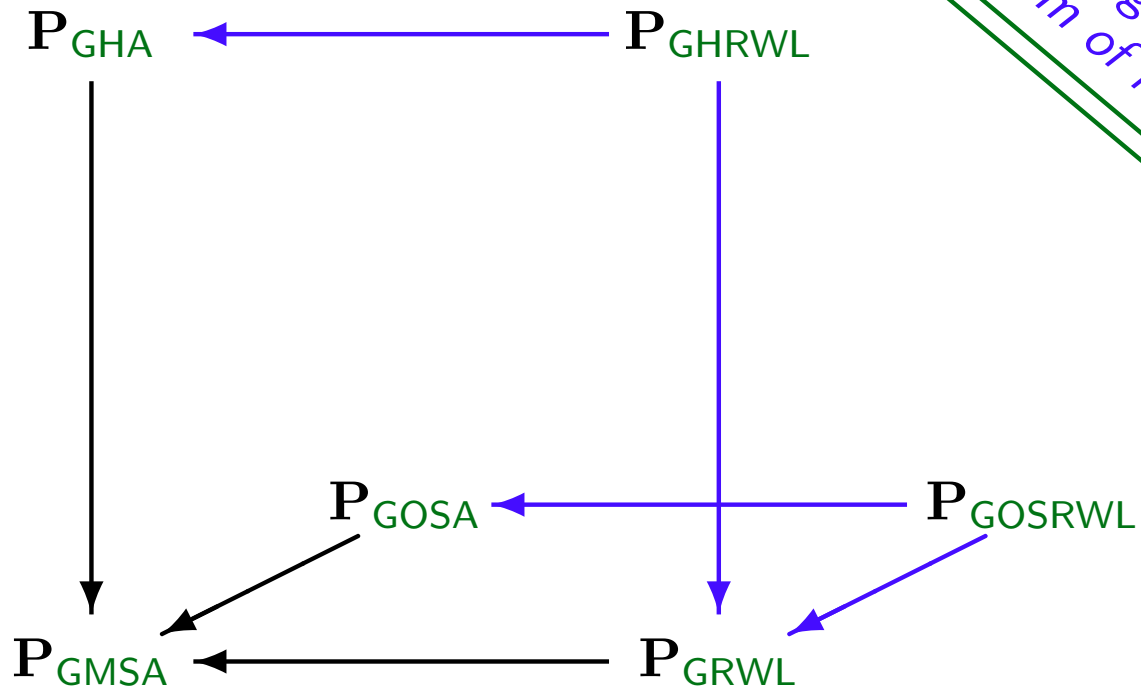

presenting the corresponding
diagram of institutions

- *Parchments for the other logics may be constructed similarly...*

Conclusion

We have systematically built:

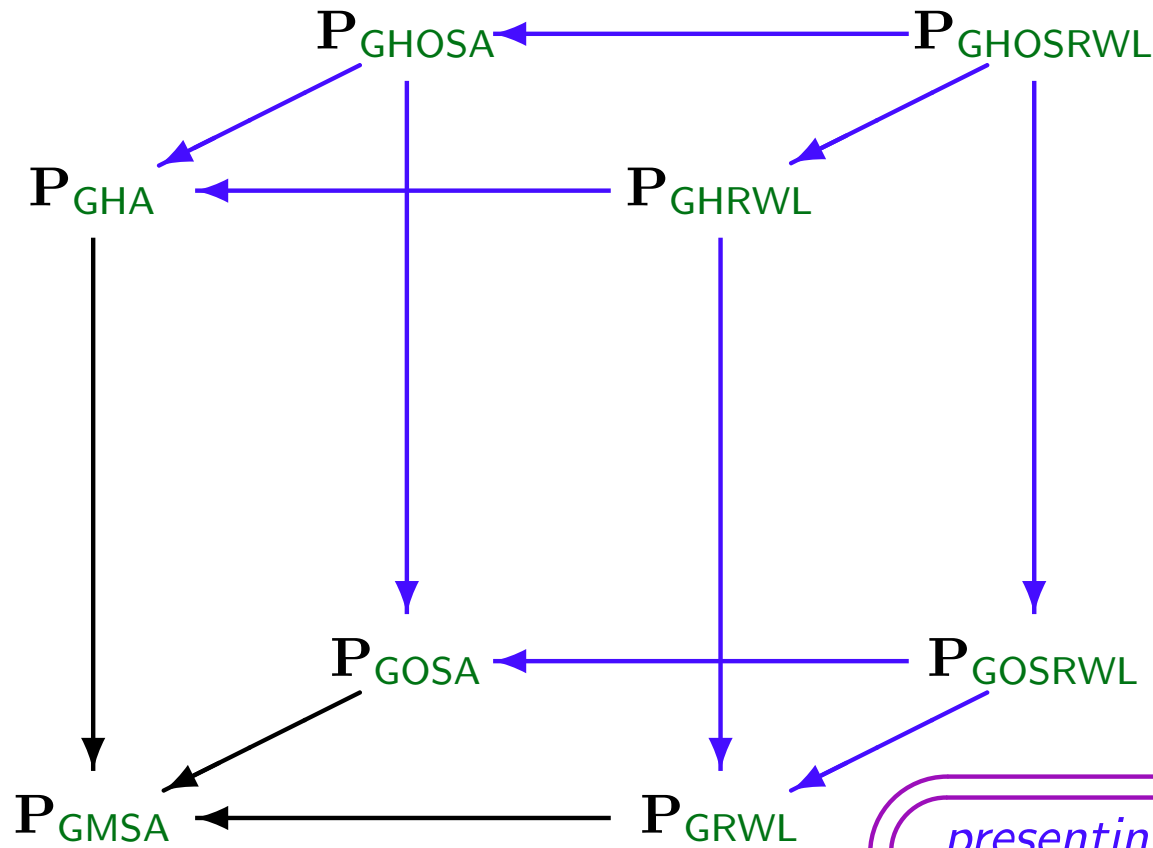

well, we are "almost" there...
many details to be filled in

presenting the corresponding cube
of CafeOBJ (ground) institutions